

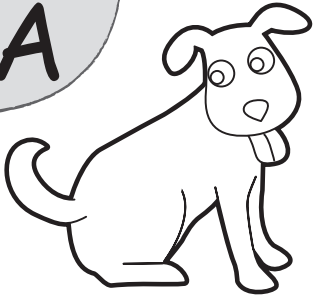

Let's say it.

disc 1
track 2

A  dog	B  hamster	C  rabbit
D  goldfish	E  cow	F  sheep

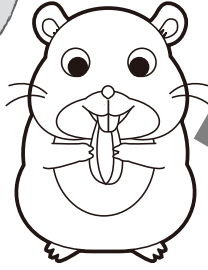
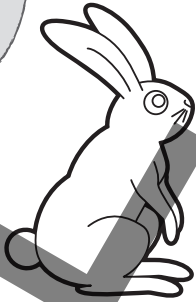
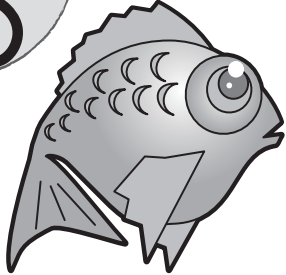

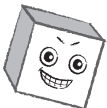
Quiz time

1.

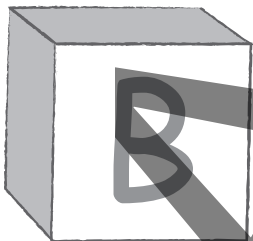

2.

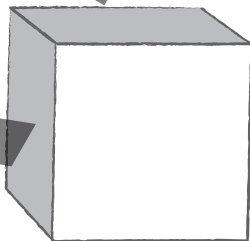

3.

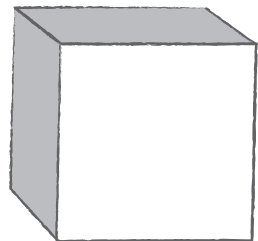

4.

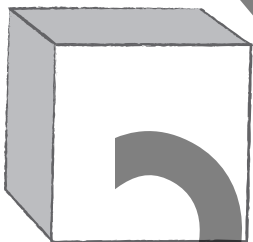

5.

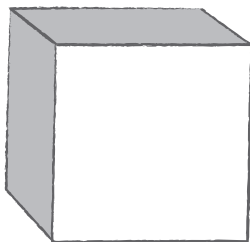



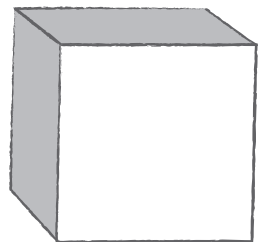

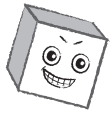
6.



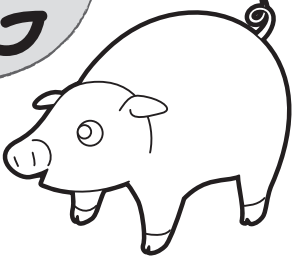
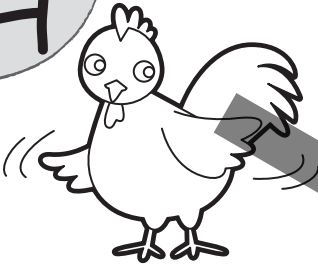

Let's say it.

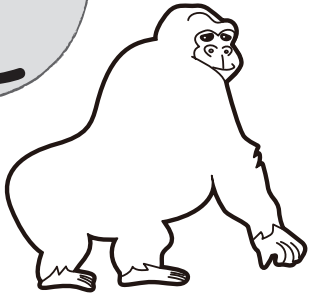
G  pig	H  chicken	I  bear
J  fox	K  giraffe	L  gorilla

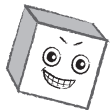

Quiz time

1.

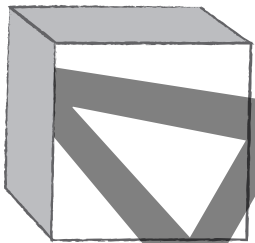

2.

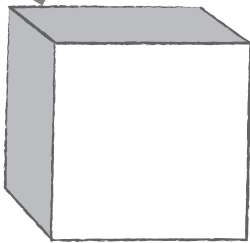

3.

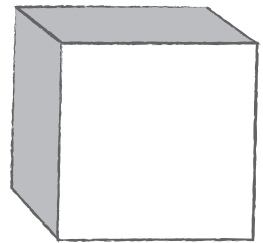

4.

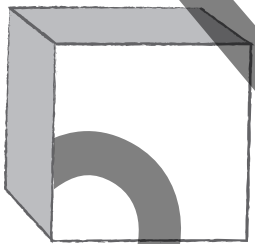

5.

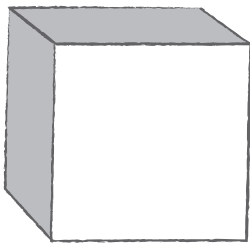



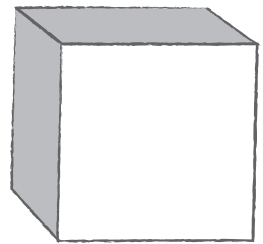



6.

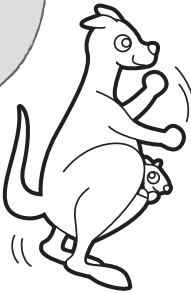

Unit 1 Animals & People

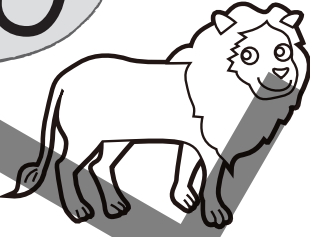
Let's say it.

disc 1
track 4

M  kangaroo	N  koala	O  lion
P  panda	Q  snake	R  tiger

Quiz time

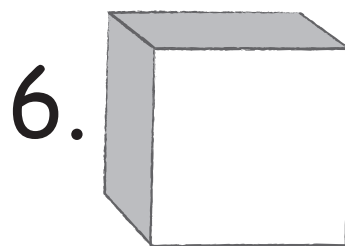
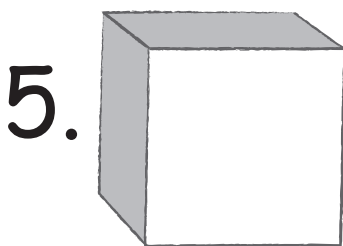
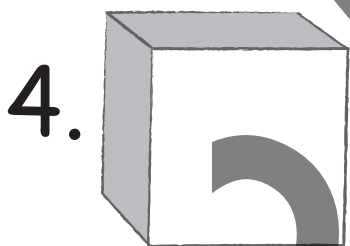
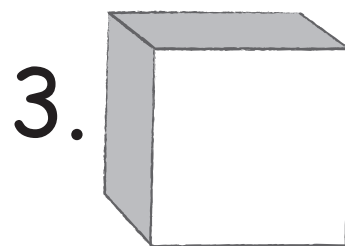
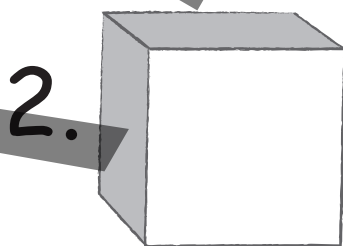
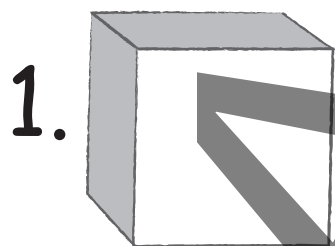

 Let's say it.

disc 1
track
5

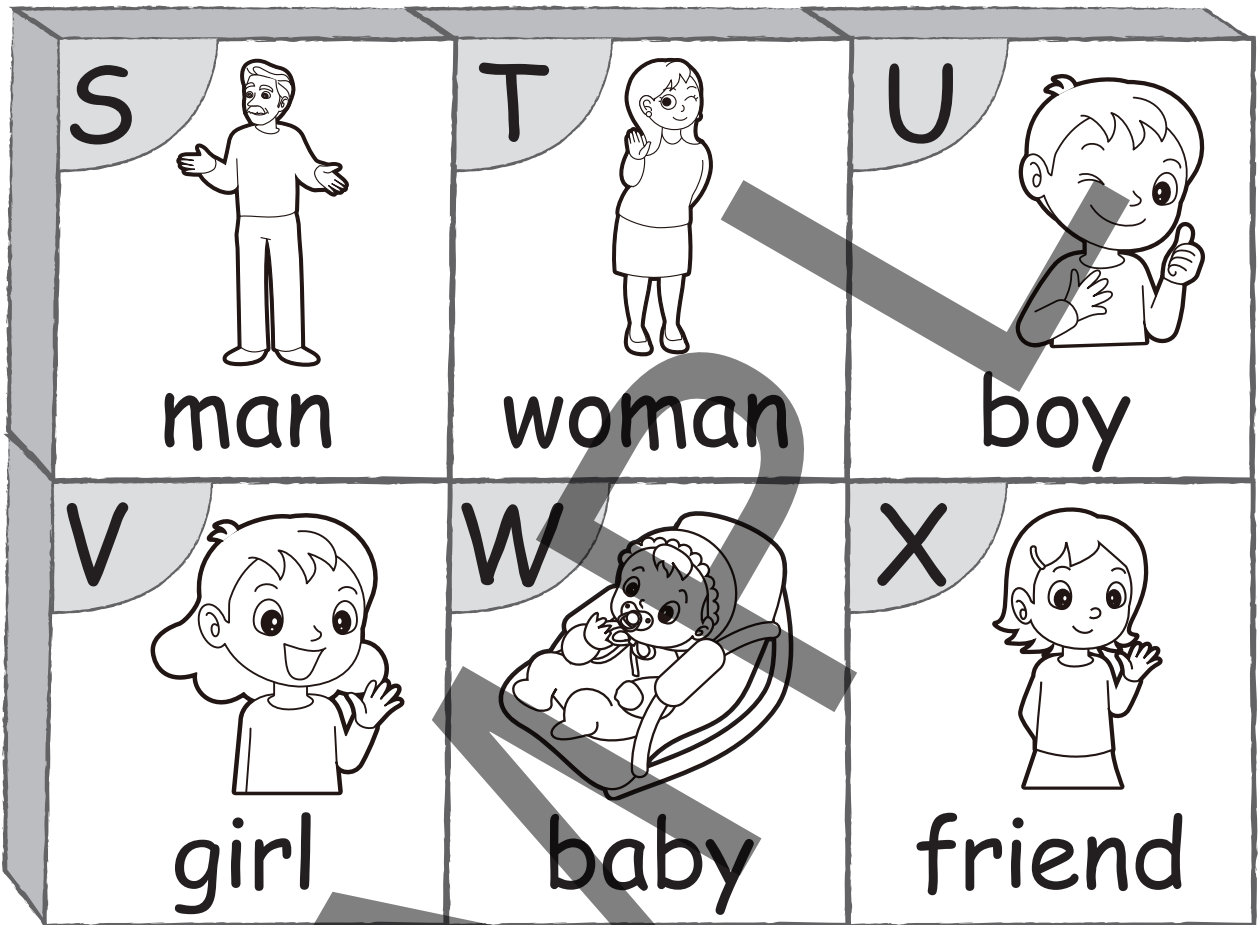



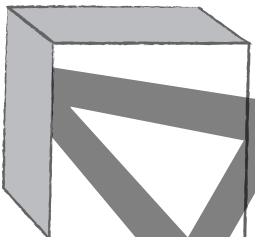
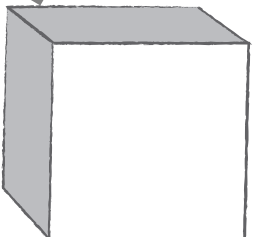
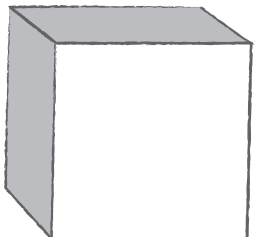
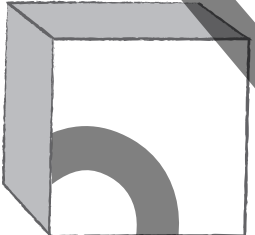
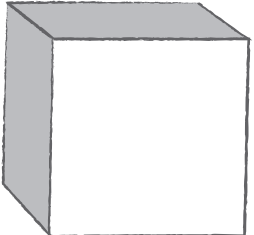
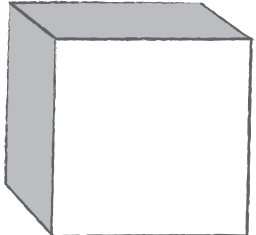

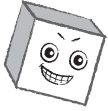

 Quiz time

1. 
2. 
3. 
4. 
5. 
6. 

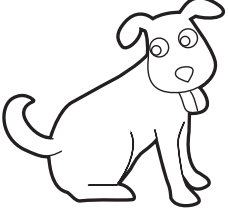
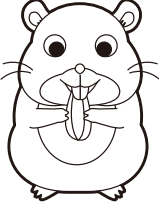

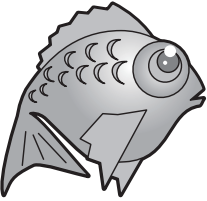
Let's review.

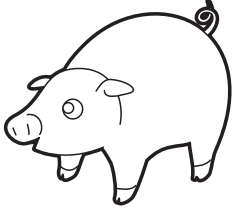
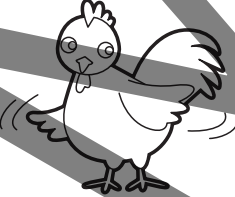
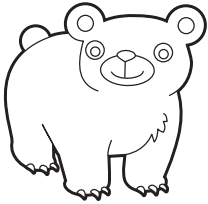
disc 1
track 6

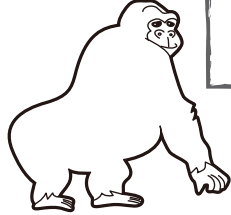
 dog	 hamster	 rabbit
 goldfish	 cow	 sheep
 pig	 chicken	 bear
 fox	 giraffe	 gorilla

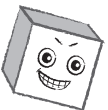





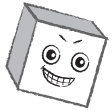





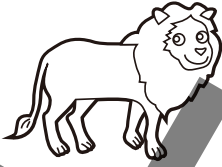

Listening quiz

disc 1
track 7



Let's review.

disc 1
track
8

 kangaroo	 koala	 lion
 panda	 snake	 tiger
 man	 woman	 boy
 girl	 baby	 friend

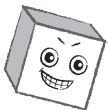





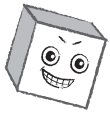



Listening quiz

disc 1
track
9



Let's read.





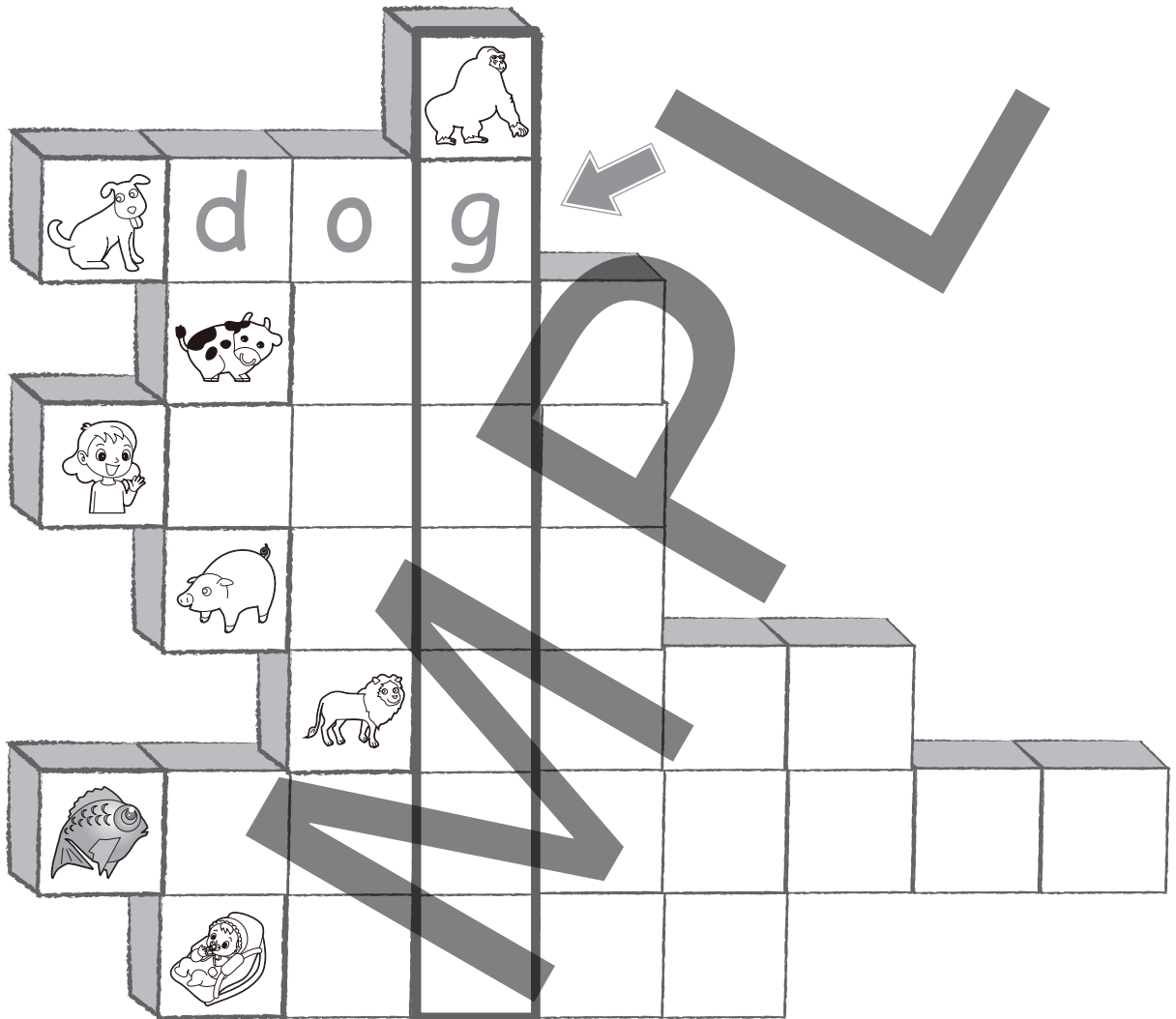

disc 1
track 10

a	bear	()	
b	fox	()	
c	rabbit	()	
d	snake	()	
e	koala	()	
f	woman	(a)	
g	man	()	
h	boy	()	

Word Blocks!

絵にあうえいごを□の中に書こう。かんせいするとブロックの中の
ふとい□のえいごがわかるよ。そのえいごを下のふとい□の中に書いてね。



	dog		lion
	cow		goldfish
	girl		baby
	pig	